













Shandong Bittel Intelligent Technology Co., Ltd.
 No. 1 Rizhao North Road, Rizhao,
 Shandong, 276800, China
www.bittelgroup.com, www.hotelphone.com
info@bittelgroup.com

Features:

- Caller ID display, supports FSK and DTMF
- Caller ID number disappears after 30 seconds
- Hearing aid compatible handset
- Data port - for connecting MODEM, fax, etc.
- Service buttons - can be programmed and kept forever
- Volume buttons   to adjust the speaker and handset volume.
- **FLASH** - The default is 100ms. Can be set from 100ms to 600ms according to the network specifications.
- **REDIAL** button redials the last number dialled
- **PROG** button – programmes the service buttons
- **MUTE** button
- LED indicator for “Line in use (blue)” and “Mute (red)”
- **R** button – Signalling the PBX to activate the flash function. The default is 100ms.
- Speaker button with indicator
- Message waiting and ringing indicator
- Busy tone disconnects automatically
- Programme service button with R.P master cloner and handheld cloner.
- Pre-dial function (32 at most), which can be automatically dialled when you pick up the handset.
- Room number shown in display
- Desktop and wall mounting

CONTROLS AND FUNCTIONAL KEYS

Features Description of the functional keys

-  - Microphone switch (handset)
-  - Signalling the PBX to activate the flash function
-  - To lower or increase the speaker and handset volume
-  - For programming
-  - Flash button
-  - Redial button
-  - For on hook dialling (speaker phone mode)
-  - Key for special services
-  - Key for special services

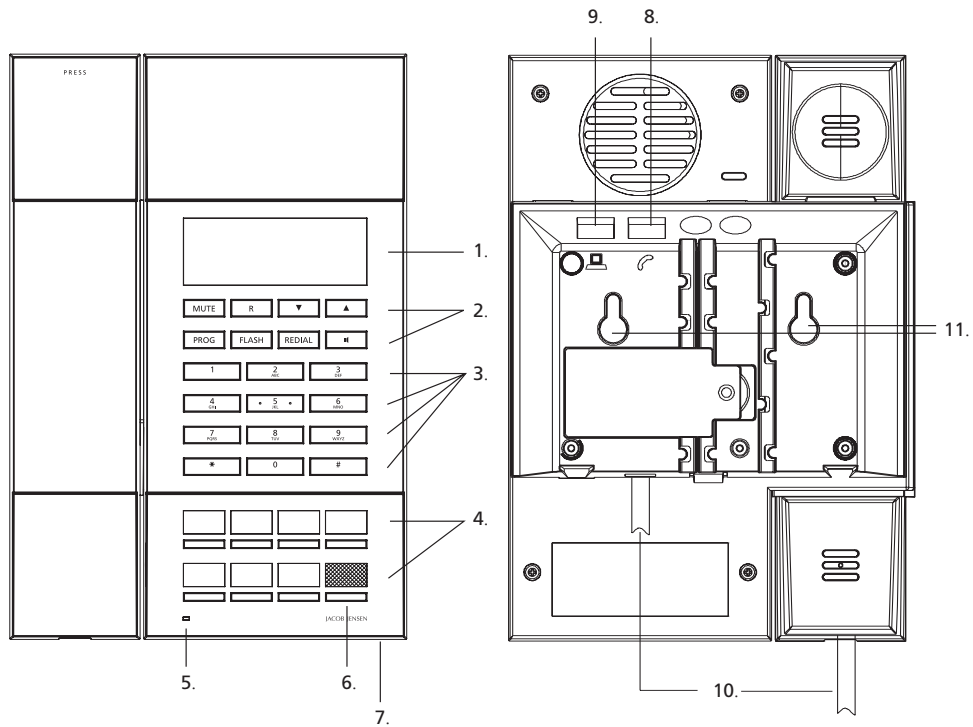

Colour scheme - front plates



Base unit - front

1. LCD screen display
2. 8 functional keys
3. 12 numerical keys
4. Service buttons
5. Indicator (LED) - for “Line in use (blue)” and “Mute (red)”
6. Message waiting indicator
7. Hands-free microphone

Base unit - rear

8. Telephone line jack
9. Data port
10. Handset cord jack
11. Holes for wall mounting

Material: ABS, PMMA.

Colours: Anthracite with coloured plates: white, silver, black, gold, red or blue

Approved standards: EN 55022 and EN 55024.